

PL1 = FREE PLUG TO BE FITTED TO SK1 AFTER WIRING

INTERNAL H/STAT

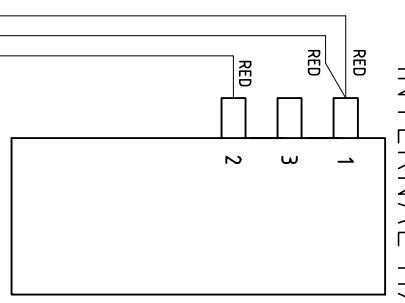

ON/OFF SWITCH

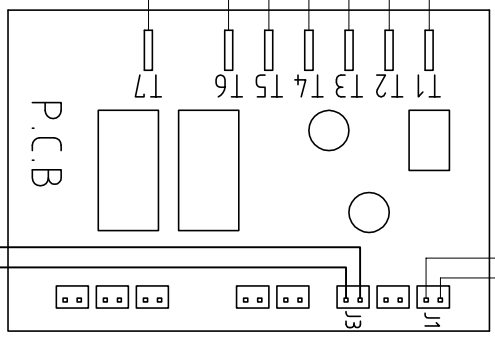
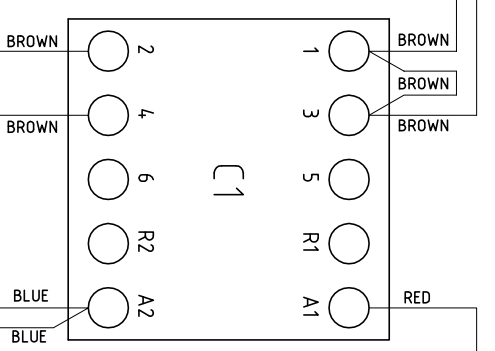
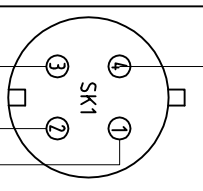
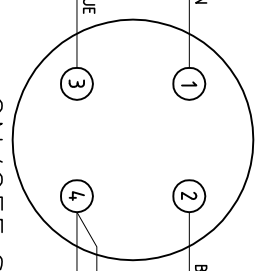

COMP. START RELAY

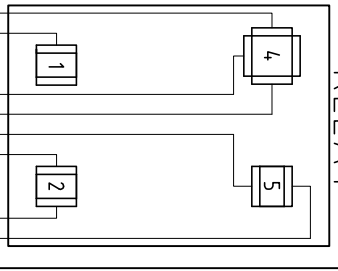

EVAP SENSOR

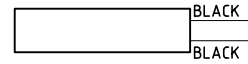

SOL VALVE



REFRIGERATION EARTH

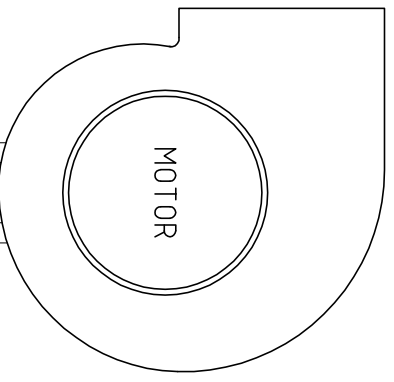
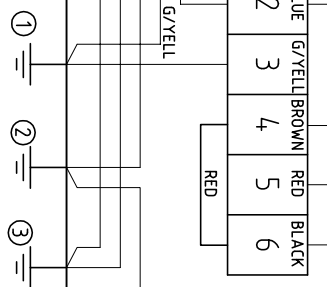
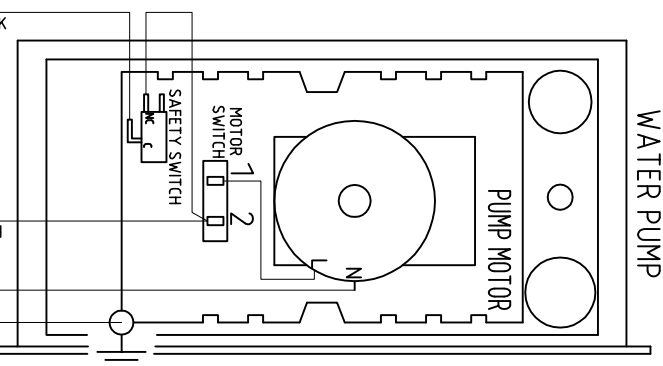
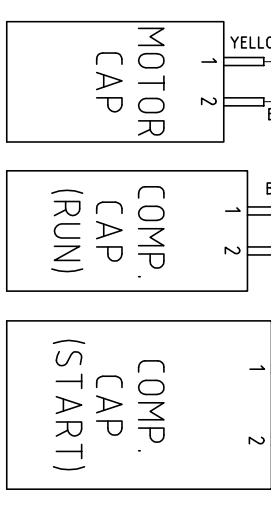
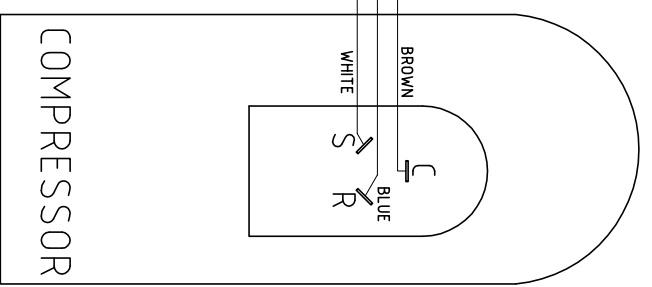
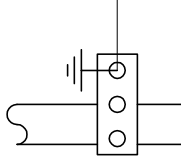

ISSUE	DATE	AMENDMENTS
1	01/11/10	ORIGINAL
2	30/11/10	1ST PROTO ISSUES - WDA
3	01/03/11	PL1 ADDED / 1ST PRODUCTION ISSUES - WDA
4	17/03/11	PUMP WIRING ARRANGEMENT CHANGED - WDA
5	01/07/11	PUMP WIRING CORRECTED - WDA
6	31/08/11	START CAP AND RELAY ADDED - WDA

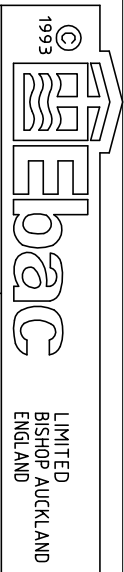

TITLE
CD200 WIRING DIAGRAM

3RD ANGLE PROJECTION DO NOT SCALE IF IN DOUBT ASK	DIMENSIONS IN m.m. TOLERANCES UNLESS OTHERWISE STATED 0.0 ± 0.25 0.00 ± 0.05 ANGULAR ± 0.5 DEGREE	MATERIAL N/A	FINISH N/A	DRAWN : W DAGLISH CAD SCALE : N/A	DRG.NO. 5010112	SHEET 1 OF 1
---	---	-----------------	---------------	--------------------------------------	--------------------	-----------------